

Dell™ E198FP Flat Panel Monitor User's Guide

About Your Monitor

[Front View](#)
[Back View](#)
[Side View](#)
[Bottom View](#)
[Monitor specifications](#)
[LCD Monitor Quality & Pixel Policy](#)
[Caring for Your Monitor](#)

Using Your Monitor Stand

[Attaching the Stand](#)
[Organizing Your Cables](#)
[Using the Tilt](#)
[Removing the Stand](#)

Setting Up Your Monitor

[Connecting Your Monitor](#)
[Using the Front Panel Buttons](#)
[Using the OSD](#)
[Using the Dell Soundbar \(Optional\)](#)

Solving Problems



[Monitor Specific Troubleshooting](#)
[Common Problems](#)
[Product Specific Problems](#)

Appendix

[CAUTION: Safety Instruction](#)
[FCC Notice \(U.S. Only\)](#)
[Contacting Dell™](#)

Notes, Notices, and Cautions

Throughout this guide, blocks of text may be accompanied by an icon and printed in bold type or in italic type. These blocks are notes, notices, and cautions, and they are used as follows:

-  **NOTE:** A NOTE indicates important information that helps you make better use of your computer.
-  **NOTICE:** A NOTICE indicates either potential damage to hardware or loss of data and tells you how to avoid the problem.
-  **CAUTION:** A CAUTION indicates the potential for property damage, personal injury, or death.

Some warnings may appear in alternate formats and may be unaccompanied by an icon. In such cases, the specific presentation of the caution is mandated by regulatory authority.

**Information in this document is subject to change without notice.
© 2007-2008 Dell™ Inc. All rights reserved.**

Reproduction in any manner whatsoever without the written permission of Dell Inc. is strictly forbidden.

Trademarks used in this text: *Dell*, the *DELL* logo, *Inspiron*, *Dell Precision*, *Dimension*, *OptiPlex*, *Latitude*, *PowerEdge*, *PowerVault*, *PowerApp*, and *Dell OpenManage* are trademarks of Dell Inc; *Microsoft* and *Windows* are registered trademarks of Microsoft Corporation; *ENERGY STAR* is a registered trademark of the U.S. Environmental Protection Agency. As an ENERGY STAR partner, Dell Inc. has determined that this product meets the ENERGY STAR guidelines for energy efficiency.

Other trademarks and trade names may be used in this document to refer to either the entities claiming the marks and names or their products. Dell Inc. disclaims any proprietary interest in trademarks and trade names other than its own.

Model E198FP

April 2007 Rev. A02

[Back to Contents Page](#)

About Your Monitor

Dell™ E198FP Flat Panel Monitor

- [Front View](#)
 - [Back View](#)
 - [Side View](#)
 - [Bottom View](#)
 - [Monitor Specifications](#)
 - [LCD Monitor Quality & Pixel Policy](#)
 - [Caring for Your Monitor](#)
-

Front View

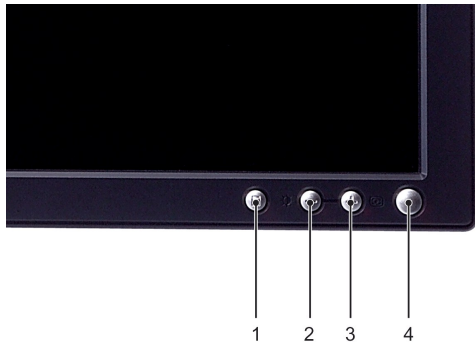

-
- 1 Menu selection button
 - 2 Brightness & Contrast / Down(-) button
 - 3 Auto-Adjust / Up(+) button
 - 4 Power on/off button with LED indicator
-

Back View

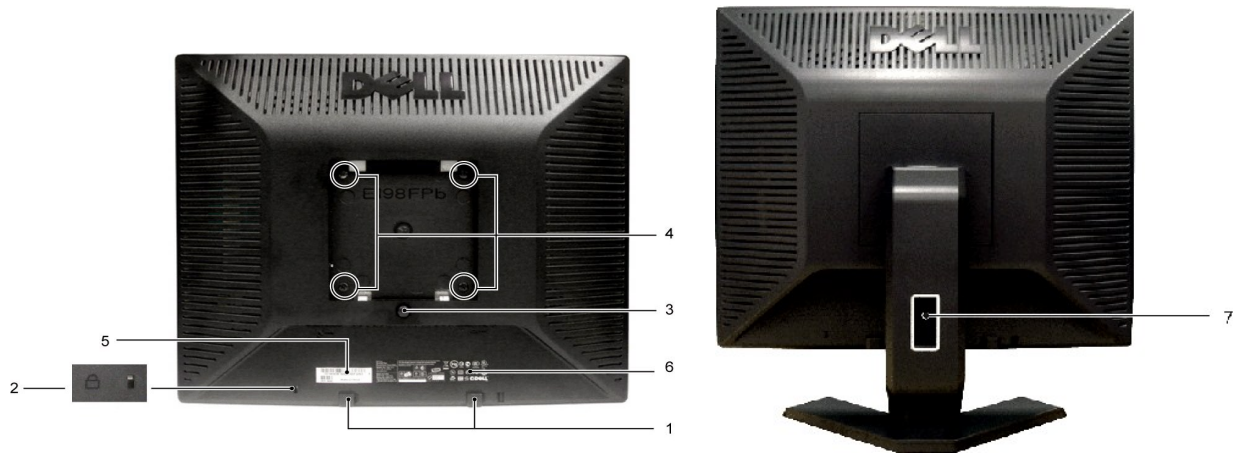

1 Dell Soundbar mounting brackets	Attach the optional Dell Soundbar.
2 Security lock slot	Attach a lock to secure your monitor.
3 Stand removal button	Press to release the stand.
4 VESA mounting holes (100mm - behind attached stand)	Use to mount monitor.
5 Barcode serial number label	Refer to this label if you need to contact Dell for technical support.
6 Regulatory rating label	List the regulatory approvals.
7 Cable holder	Help organize cables by passing them through the holders.

Side View



Right side



Left side

Bottom View

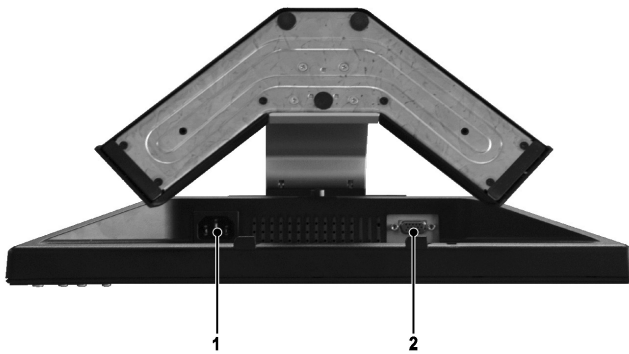

-
- 1 AC power cord connector
 - 2 VGA connector
-

Monitor Specifications

General

Model number E198FP

Flat Panel

Screen type	Active matrix - TFT LCD
Screen dimensions	19 inches (19-inch diagonal viewable image size)
Preset display area:	
Horizontal	376.3 mm (14.8 inches)

Vertical	301.1 mm (11.8 inches)
Pixel pitch	0.294 mm
Viewing angle	160°X (Vertical) typical, 160°X (Horizontal) typical
Luminance output	300 cd/m ² (typ)
Contrast ratio	800:1 (typ)
Faceplate coating	Antiglare with hard-coating 3H
Backlight	4 CCFLs backlight
Response Time	5ms typical (Black to White)

Resolution

Horizontal scan range	30 kHz to 81 kHz (automatic)
Vertical scan range	56 Hz to 76 Hz
Optimal preset resolution	1280 x 1024 at 60 Hz
Highest preset resolution	1280 x 1024 at 75 Hz

Preset Display Modes

The following table lists the preset modes for which Dell guarantees image size and centering:

Display Mode	Horizontal Frequency (kHz)	Vertical Frequency (Hz)	Pixel Clock (MHz)	Sync Polarity (Horizontal/Vertical)
VGA, 720 x 400	31.5	70.1	28.3	-/+
VGA, 640 x 480	31.5	59.9	25.2	-/-
VESA, 640 x 480	37.5	75.0	31.5	-/-
VESA, 800 x 600	37.9	60.3	40.0	+/+
VESA, 800 x 600	46.9	75.0	49.5	+/+
VESA, 1024 x 768	48.4	60.0	65.0	-/-
VESA, 1024 x 768	60.0	75.0	78.8	+/+
VESA, 1152 x 864	67.5	75.0	108.0	+/+
VESA, 1280 x 1024	64.0	60.0	108.0	+/+
VESA, 1280 x 1024	80.0	75.0	135.0	+/+

Electrical

The following table lists the electrical specification:

Video input signals	Analog RGB: 0.7 Volts +/-5%, 75 ohm input impedance
Synchronization input signals	separate horizontal and vertical, 3.3V Cmos or 5V TTL level, positive or negative sync.
AC input voltage / frequency / current	100 to 240 VAC / 50 or 60 Hz + 3 Hz / 1.0 A (Max.)
Inrush current	120V: 40A (Max.) 240V: 80A (Max.)

Physical Characteristics

The following table lists the physical characteristics:

Signal cable type	D-sub: Detachable, Analog, 15pin, shipped attached to the monitor
Dimensions (with stand):	
Height	410.9 mm (16.17 inches)
Width	412.7 mm (16.2 inches)
Depth	144.4 mm (5.7 inches)
Weight	
Monitor (Stand and Head)	4.83 kg (10.7 lb)
Monitor Flat panel only (VESA Mode)	3.81 kg (8.4 lb)
Weight with packaging	6.32 kg (13.9 lb)

Environmental

The following table lists the environmental limitation:

Temperature:	
Operating	5°CX to 35°CXC (41°FX to 95°FXF)
Nonoperating	Storage: 0°CX to 60°CXC (32°FX to 140°FXF) Shipping: -20°CX to 60°CXC(-4°FX to 140°FXF)
Humidity:	
Operating	10% to 80% (noncondensing)
Nonoperating	Storage: 5% to 90% (noncondensing) Shipping: 5% to 90%(noncondensing)
Altitude:	
Operating	3,657.6 m (12,000 ft) max
Nonoperating	12,192 m (40,000 ft) max
Thermal dissipation	138.44 BTU/hour (maximum) 129.92 BTU/hour (typical)

Power Management Modes

If you have VESA's DPMS compliance display card or software installed in your PC, the monitor automatically reduces its power consumption when not in use. This is referred to as Power Save Mode*. If input from keyboard, mouse or other input devices is detected by the computer, the monitor will automatically "wake up". The following table shows the power consumption and signaling of this automatic power-saving feature:

VESA Modes	Horizontal Sync	Vertical Sync	Video	Power Indicator	Power Consumption
Normal operation	Active	Active	Active	Green	40.6 W (maximum)* 38.1 W (normal)**
Active-off mode	Inactive	Inactive	Blanked	Amber	Less than 2 W
Switch off	-	-	-	Off	Less than 1 W

* With Audio
** Without Audio

 NOTE: The [OSD](#) functions only in the 'normal operation' mode. Otherwise one of the following messages appears depending upon the selected input.

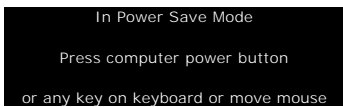

Activate the computer and wake up the monitor to gain access to the [OSD](#).

Pin Assignments

VGA Connector

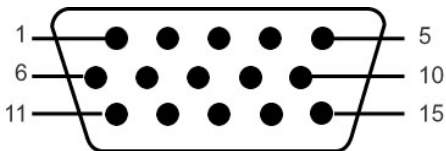

Pin Number	15-pin Side of the Connected Signal Cable
1	Video-Red
2	Video-Green
3	Video-Blue
4	GND
5	Self-test
6	GND-R
7	GND-G
8	GND-B
9	Computer 5V/3.3V

10	GND-sync
11	GND
12	DDC data
13	H-sync
14	V-sync
15	DDC clock

Plug and Play Capability

You can install the monitor in any Plug and Play-compatible system. The monitor automatically provides the computer system with its Extended Display Identification Data (EDID) using Display Data Channel (DDC) protocols so the system can configure itself and optimize the monitor settings. If required, the user can select different settings, but in most cases monitor installation is automatic.

LCD Monitor Quality & Pixel Policy

During the LCD Monitor manufacturing process, it is not uncommon for one or more pixels to become fixed in an unchanging state. The visible result is a fixed pixel that appears as an extremely tiny dark or bright discolored spot.

In almost every case, these fixed pixels are hard to see and do not detract from display quality or usability. A display with 1 to 5 fixed pixels is considered normal and within competitive standards. For more information, see Dell Support site at: support.dell.com.

Caring for Your Monitor

To help maintain the best image quality on your monitor, use a dynamically changing screen saver and power off your monitor when not in use.

 **CAUTION:** Read and follow the [Safety Instructions](#) before cleaning the monitor.

 **CAUTION:** Before cleaning the monitor, unplug the monitor from the electrical outlet.

- 1 To clean your antistatic screen, lightly dampen a soft, clean cloth with water. If possible, use a special screen-cleaning tissue or solution suitable for the antistatic coating. Do not use benzene, thinner, ammonia, abrasive cleaners, or compressed air.
- 1 Use a lightly-dampened, warm cloth to clean the plastics. Avoid using detergent of any kind as some detergents leave a milky film on the plastics.
- 1 If you notice a white powder when you unpack your monitor, wipe it off with a cloth. This white powder occurs during the shipping of the monitor.
- 1 Handle your monitor with care as darker-colored plastics may scratch and show white scuff marks more than lighter-colored monitor.

[Back to Contents Page](#)

Appendix

Dell™ E198FP Flat Panel Monitor

- [Safety Instructions](#)
 - [FCC Notice \(U.S. Only\)](#)
 - [Contacting Dell™](#)
-

CAUTION: Safety Instructions



CAUTION: Use of controls, adjustments, or procedures other than those specified in this documentation may result in exposure to shock, electrical hazards, and/or mechanical hazards.

Read and follow these instructions when connecting and using your computer monitor:

- 1 To help avoid damaging your computer, be sure that the voltage selection switch on the power supply for the computer is set to match the alternating current (AC) power available at your location:
 - o 115 volts (V)/60 hertz (Hz) in most of North and South America and some Far Eastern countries such as Japan, South Korea (also 220 volts (V)/60 hertz (Hz)), and Taiwan.
 - o 230 volts (V)/50 hertz (Hz) in most of Europe, the Middle East, and the Far East.
- 1 Always be sure that your monitor is electrically rated to operate with the AC power available in your location.



NOTE: This monitor does not need or have a voltage selection switch for setting the AC voltage input. It will automatically accept any AC input voltage according to the ranges defined in the "Electrical Specifications" section in the User's Guide.

- 1 Do not store or use the monitor in locations that are exposed to heat, direct sunlight, or extreme cold.
- 1 Avoid moving the monitor between locations with large temperature differences.
- 1 Do not subject the monitor to severe vibration or high impact conditions. For example, do not place the monitor inside a car trunk.
- 1 Do not store or use the monitor in locations exposed to high humidity or dusty environment.
- 1 Do not allow water or other liquids to spill on or into the monitor.
- 1 Keep flat panel monitor in room temperature conditions. Excessive cold or hot conditions can have an adverse effect on the liquid crystal of the display.
- 1 Never insert anything metallic into the monitor openings. Doing so may create the danger of electric shock.
- 1 To avoid electric shock, never touch the inside of the monitor. Only a qualified technician should open the monitor case.
- 1 Never use your monitor if the power cable has been damaged. Ensure that nothing rests on your computer's cables and that the cables are not located where they can be stepped on or tripped over.
- 1 Be sure to grasp the plug, not the cable, when disconnecting the monitor from an electric socket.
- 1 Openings in the monitor cabinet are provided for ventilation. To prevent overheating, these openings should not be blocked or covered. Avoid using the monitor on a bed, sofa, rug, or other soft surface, as doing so may block the ventilation openings in the bottom of the cabinet. If you place the monitor in a bookcase or an enclosed space, be sure to provide adequate ventilation and air flow.
- 1 Place your monitor in a location with low humidity and minimum dust. Avoid places similar to a damp basement or dusty hallway.
- 1 Do not expose the monitor to rain or use it near water (in kitchens, next to swimming pools, etc.). If the monitor accidentally gets wet, unplug it and contact an authorized dealer immediately. You can clean the monitor with a damp cloth when necessary, being sure to unplug the monitor first.
- 1 Place the monitor on a solid surface and treat it carefully. The screen is made of glass and can be damaged if dropped or hit sharply.
- 1 Locate your monitor near an easily accessible electric outlet.
- 1 If your monitor does not operate normally - in particular, if there are any unusual sounds or smells coming from it - unplug it immediately and contact an authorized dealer or service center.
- 1 Do not attempt to remove the back cover, as you will be exposed to an electrical shock hazard. The back cover should only be removed by qualified service personnel.
- 1 High temperatures can cause problems. Don't use your monitor in direct sunlight, and keep it away from heaters, stoves, fireplaces, and other sources of heat.
- 1 Unplug the monitor when it is going to be left unused for an extended period of time.
- 1 Unplug your monitor from the electric outlet before any service is performed.
- 1  LAMP(S) INSIDE THIS PRODUCT CONTAIN(S) MERCURY AND MUST BE RECYCLED OR DISPOSED OFF ACCORDING TO LOCAL, STATE OR FEDERAL LAWS. FOR MORE INFORMATION, GO TO WWW.DELL.COM/HG OR CONTACT THE ELECTRONIC INDUSTRIES ALLIANCE AT WWW.EIAE.ORG.

FCC Notice (U.S. Only)

FCC Class B

This equipment generates, uses, and can radiate radio frequency energy and, if not installed and used in accordance with the manufacturer's instruction manual, may cause interference with radio and television reception. This equipment has been tested and found to comply with the limits for a Class B digital device pursuant to Part 15 of the FCC Rules.

This device complies with Part 15 of the FCC Rules. Operation is subject to the following two conditions:

1. This device may not cause harmful interference.
2. This device must accept any interference received, including interference that may cause undesired operation.



NOTICE: The FCC regulations provide that changes or modifications not expressly approved by Dell™ Inc. could void your authority to operate this equipment.

These limits are designed to provide reasonable protection against harmful interference in a residential installation. However, there is no guarantee that interference will not occur in a particular installation. If this equipment does cause harmful interference with radio or television reception, which can be determined by turning the equipment off and on, you are encouraged to try to correct the interference by one or more of the following measures:

- 1 Reorient the receiving antenna.
- 1 Relocate the system with respect to the receiver.
- 1 Move the system away from the receiver.
- 1 Plug the system into a different outlet so that the system and the receiver are on different branch circuits.

If necessary, consult a representative of Dell™ Inc. or an experienced radio/television technician for additional suggestions.

The following information is provided on the device or devices covered in this document in compliance with the FCC regulations:

- 1 Product name: E198FP
- 1 Model number: E198FPb
- 1 Company name:
Dell Inc.
Worldwide Regulatory Compliance & Environmental Affairs
One Dell Way
Round Rock, Texas 78682 USA
512-338-4400

Contacting DellIT

You can contact Dell through the Internet and by phone:

- 1 For support through the web, go to support.dell.com.
- 1 For worldwide support through the web, use the **Choose A Country/Region** menu near the bottom of the page, or see the web addresses listed in the following table.
- 1 For support by e-mail, see the e-mail addresses listed in the following table.



NOTE: The contact information provided was deemed correct at the time that this document went to print and is subject to change.



NOTE: In certain countries, support specific to Dell™ XPS™ computers is available at a separate telephone number listed for participating countries. If you do not see a telephone number listed that is specific for XPS computers, you may contact Dell through the support number listed and your call will be routed appropriately.

- 1 For support by phone, use the phone numbers and codes provided in the following table. If you need assistance in determining which codes to use, contact a local or an international operator.



NOTE: The contact information provided was deemed correct at the time that this document went to print and is subject to change.

Country (City) International Access Code Country Code City Code	Service Type	Area Codes, Local Numbers, and Toll-Free Numbers Web and E-Mail Address
Anguilla	Online Support	www.dell.com/ai
	E-mail Address	la-techsupport@dell.com
	Technical Support, Customer Service, Sales	toll-free: 800-335-0031
Antigua and Barbuda	Online Support	www.dell.com.ag
		la-techsupport@dell.com
	Technical Support, Customer Service, Sales	1-800-805-5924
Aomen Country Code:853	Technical Support	toll-free:0800-105
	Customer Service (Xiamen, China)	34 160 910
	Transaction Sales (Xiamen, China)	29 693 115
Argentina (Buenos Aires)	Online Support	www.dell.com.ar
	E-mail for Desktops and	la-techsupport@dell.com

International Access Code: 00 Country Code: 54 City Code: 11	Portables	
	E-mail for Servers and EMC® Storage Products	la-techsupport@dell.com
	Customer Service	toll-free: 0-800-444-0730
	Technical Support– Dell PowerApp™, Dell PowerEdge™, Dell PowerConnect™, and Dell PowerVault™	toll-free: 0-800-222-0154
	Technical Support Services	toll-free: 0-800-444-0724
Sales		0-810-444-3355
Aruba	Online Support	www.dell.com.aw
		la-techsupport@dell.com
	Technical Support, Customer Service, Sales	toll-free: 800-1578
Australia (Sydney) International Access Code: 0011 Country Code: 61 City Code: 2	Online Support	support.ap.dell.com
		support.ap.dell.com.contactus
	Technical Support	
	Technical Support for XPS computers onlycomputers only	toll-free: 1300 790 877
	Home and Home Office	toll-free: 1300-655-533
	Medium and Large Business	toll-free: 1800-633-559
	Small Business, Education, Local Government	toll-free: 1800-060-889
	Customer Service	toll-free: 1300-662-196
Austria (Vienna) International Access Code: 900 Country Code: 43 City Code: 1	Online Support	support.euro.dell.com
		tech_support_central_europe@dell.com
	Technical Support for XPS computers onlycomputers only	08 20 24 05 30 81
	Home/Small Business Sales	08 20 24 05 30 00
	Home/Small Business Fax	08 20 24 05 30 49
	Home/Small Business Customer Service	08 20 24 05 30 14
	Home/Small Business Support	08 20 24 05 30 17
	Preferred Accounts/Corporate Customer Service	08 20 24 05 30 16
	Preferred Accounts/Corporate Support	08 20 24 05 30 17
	Switchboard	0820 240 530 00
Bahamas	Online Support	www.dell.com/bs
		la-techsupport@dell.com
	Technical Support, Customer Service, Sales	toll-free: 1-866-874-3038
Barbados	Online Support	www.dell.com/bb
		la-techsupport@dell.com
	Technical Support, Customer Service, Sales	1-800-534-3142
Belgium (Brussels) International Access Code: 00 Country Code: 32 City Code: 2	Online Support	support.euro.dell.com
	Technical Support for XPS computers onlycomputers only	02 481 92 96
	General Support	02 481 92 88
	General Support Fax	02 481 92 95
	Customer Service	02 713 15 .65
	Corporate Sales	02 481 91 00
	Fax	02 481 92 99
	Switchboard	02 481 91 00
Bermuda	Online Support	www.dell.com/bm
		la-techsupport@dell.com
	Technical Support, Customer Service, Sales	1-877-890-0751

Bolivia	Online Support	www.dell.com/bo	
		la-techsupport@dell.com	
	Technical Support, Customer Service, Sales	toll-free: 800-10-0238	
Brazil International Access Code: 00 Country Code: 55 City Code: 51	Online Support	www.dell.com/br	
		BR_TechSupport@dell.com	
	Customer Service and Tech Support	0800 970 3355	
	Technical Support Fax	51 2104 5470	
	Customer Service Fax	51 2104 5480	
	Sales	0800 970 3390	
British Virgin Islands	Technical Support, Customer Service, Sales	toll-free: 1-866-278-6820	
Brunei Country Code: 673	Technical Support (Penang, Malaysia)	604 633 4966	
	Customer Service (Penang, Malaysia)	604 633 3101 or toll-free: 801 1012	
	Transaction Sales (Penang, Malaysia)	604 633 3101 or toll-free: 801 1012	
Canada (North York, Ontario) International Access Code: 011	Online Order Status	www.dell.ca/ostatus	
	Online Support	support.ca.dell.com	
	AutoTech (automated Hardware and Warranty Support)	toll-free: 1-800-247-9362	
	Customer Service		
	Home/Home Office	toll-free: 1-800-847-4096	
	Small Business	toll-free: 1-800-906-3355	
	Medium/Large Business, Government, Education	toll-free: 1-800-387-5757	
	Hardware Warranty Phone Support		
	XPS Computers Only	toll-free: 1-866-398-8977	
	Computers for Home/Home Office	toll-free: 1-800-847-4096	
	Computers for Small/Medium/Large Business, Government	toll-free: 1-800-387-5757	
	Printers, Projectors, Televisions, Handheld, Digital Jukebox, and Wireless	1-877-335-5767	
	Sales		
	Home and Home Office Sales	toll-free: 1-800-999-3355	
	Small Business	toll-free: 1-800-387-5752	
	Medium/Large Business, Government	toll-free: 1-800-387-5755	
	Spare Parts and Extended Service	1 866 440 3355	
	Cayman Islands	Online Support	la-techsupport@dell.com
		Technical Support, Customer Service, Sales	1-877-262-5415
Chile (Santiago) Country Code: 56 City Code: 2	Online Support	www.dell.com/cl	
		la-techsupport@dell.com	
	Sales and Customer Support	toll-free: 1230-020-3397 or 800-20-1385	
China (Xiamen) Country Code: 86 City Code: 592	Online Support	support.dell.com.cn	
	Technical Support E-mail	cn_support@dell.com	
	Customer Service E-mail	customer_cn@dell.com	
	Technical Support Fax	592 818 1350	
	Technical Support – XPS computers only	toll-free: 800 858 0540	
	Technical Support – Dell™ Dimension™ and Dell Inspiron™	toll-free: 800 858 2969	
	Technical Support – Dell OptiPlex™, Dell Latitude™, and Dell Precision™	toll-free: 800 858 0950	
Technical Support – Servers and Storage	toll-free: 800 858 0960		

	Technical Support – Projectors, PDAs, Switches, Routers, etc.	toll-free: 800 858 2920
	Technical Support – Printers	toll-free: 800 858 2311
	Customer Service	toll-free: 800 858 2060
	Customer Service Fax	592 818 1308
	Home and Small Business	toll-free: 800 858 2222
	Preferred Accounts Division	toll-free: 800 858 2557
	Large Corporate Accounts GCP	toll-free: 800 858 2055
	Large Corporate Accounts Key Accounts	toll-free: 800 858 2628
	Large Corporate Accounts North	toll-free: 800 858 2999
	Large Corporate Accounts North Government and Education	toll-free: 800 858 2955
	Large Corporate Accounts East	toll-free: 800 858 2020
	Large Corporate Accounts East Government and Education	toll-free: 800 858 2669
	Large Corporate Accounts Queue Team	toll-free: 800 858 2572
	Large Corporate Accounts South	toll-free: 800 858 2355
	Large Corporate Accounts West	toll-free: 800 858 2811
	Large Corporate Accounts Spare Parts	toll-free: 800 858 2621
Colombia	Online Support	www.dell.com/co
		la-techsupport@dell.com
	Technical Support, Customer Service, Sales	01-800-915-4755
Costa Rica	Online Support	www.dell.com/cr
		la-techsupport@dell.com
	Technical Support, Customer Service, Sales	0800-012-0231
Czech Republic (Prague) International Access Code: 00 Country Code: 420	Online Support	support.euro.dell.com
		czech_dell@dell.com
	Technical Support	22537 2727
	Customer Service	22537 2707
	Fax	22537 2714
	Technical Fax	22537 2728
	Switchboard	22537 2711
Denmark (Copenhagen) International Access Code: 00 Country Code: 45	Online Support	support.euro.dell.com
	Technical Support for XPS computers only	7010 0074
	Technical Support	7023 0182
	Customer Service – Relational	7023 0184
	Home/Small Business Customer Service	3287 5505
	Switchboard – Relational	3287 1200
	Switchboard Fax – Relational	3287 1201
	Switchboard – Home/Small Business	3287 5000
	Switchboard Fax – Home/Small Business	3287 5001
Dominica	Online Support	www.dell.com/dm
		la-techsupport@dell.com
	Technical Support, Customer Service, Sales	toll-free: 1-866-278-6821
Dominican Republic	Online Support	www.dell.com/do
		la-techsupport@dell.com

	Technical Support, Customer Service, Sales	1-800-156-1588
Ecuador	Online Support	www.dell.com/ec
		la-techsupport@dell.com
	Technical Support, Customer Service, Sales (calling from Quito)	toll-free: 999-119-877-655-3355
	Technical Support, Customer Service, Sales (calling from Guayaquil)	toll-free: 1800-999-119-877-655-3355
El Salvador	Online Support	www.dell.com/sv
		la-techsupport@dell.com
	Technical Support, Customer Service, Sales	800-6132
Finland (Helsinki) International Access Code: 990 Country Code: 358 City Code: 9	Online Support	support.euro.dell.com
		fi_support@dell.com
	Technical Support	0207 533 555
	Customer Service	0207 533 538
	Switchboard	0207 533 533
	Fax	0207 533 530
	Sales under 500 employees	0207 533 540
	Sales over 500 employees	0207 533 533
France (Paris) (Montpellier) International Access Code: 00 Country Code: 33 City Codes: (1) (4)	Online Support:	support.euro.dell.com
	Technical Support for XPS computers only	0825 387 129
	Home and Small Business	
	Technical Support	0825 387 270
	Customer Service	0825 823 833
	Switchboard	0825 004 700
	Switchboard (calls from outside of France)	04 99 75 40 00
	Sales	0825 004 700
	Fax	0825 004 701
	Fax (calls from outside of France)	04 99 75 40 01
	Corporate	
	Technical Support	0825 004 719
	Customer Service	0825 338 339
	Switchboard	01 55 94 71 00
	Sales	01 55 94 71 00
	Fax	01 55 94 71 01
Germany (Frankfurt) International Access Code: 00 Country Code: 49 City Code: 69	Online Support	support.euro.dell.com
		tech_support_central_europe@dell.com
	Technical Support for XPS computers only	069 9792 7222
	Technical Support	069 9792-7200
	Home/Small Business Customer Service	0180-5-224400
	Global Segment Customer Service	069 9792-7320
	Preferred Accounts Customer Service	069 9792-7320
	Large Accounts Customer Service	069 9792-7320
	Public Accounts Customer Service	069 9792-7320
	Switchboard	069 9792-7000
Greece International Access Code: 00 Country Code: 30	Online Support	support.euro.dell.com
	Technical Support	00800-44 14 95 18
	Gold Service Technical Support	00800-44 14 00 83
	Switchboard	2108129810
	Gold Service Switchboard	2108129811
	Sales	2108129800
	Fax	2108129812

Grenada	Online Support	www.dell.com/gd
		la-techsupport@dell.com
	Technical Support, Customer Service, Sales	toll-free: 1-866-540-3355
Guatemala	Online Support	www.dell.com/gt
		la-techsupport@dell.com
	Technical Support, Customer Service, Sales	1-800-999-0136
Guyana	Online Support	la-techsupport@dell.com
	Technical Support, Customer Service, Sales	toll-free: 1-877-270-4609
Hong Kong International Access Code: 001 Country Code: 852	Online Support	support.ap.dell.com
		support.dell.com.cn/email
	Technical Support – XPS computers only	00852-3416 6923
	Technical Support – Dimension and Inspiron	00852-2969 3188
	Technical Support – OptiPlex, Latitude, and Dell Precision	00852-2969 3191
	Technical Support – Servers and Storage	00852-2969 3196
	Technical Support – Projectors, PDAs, Switches, Routers, etc.	00852-3416 0906
	Customer Service	00852-3416 0910
	Large Corporate Accounts	00852-3416 0907
	Global Customer Programs	00852-3416 0908
	Medium Business Division	00852-3416 0912
Home and Small Business Division	00852-2969 3105	
India	Online Support	support.ap.dell.com
	Portable and Desktop Support	
	Desktop Support E-mail	india_support_desktop@dell.com
	Portable Support E-mail	india_support_notebook@dell.com
	Phone Numbers	080-25068032 or 080-25068034 or your city STD code + 60003355 or toll-free: 1-800-425-8045
	Server Support	
	E-mail	india_support_Server@dell.com
	Phone Numbers	080-25068032 or 080-25068034 or your city STD code + 60003355 or toll-free: 1800 425 8045
	Gold Support Only	
	E-mail	eec_ap@dell.com
	Phone Numbers	080-25068033 or your city STD code + 60003355 or toll-free: 1-800-425-9045
	XPS Support Only	
	E-mail	Indiaxps_AP@dell.com
	Phone Numbers	080-25068066 or toll-free: 1-800-425-2066
	Customer Service	
	Home and Small Business	India_care_HSB@dell.com toll-free: 1800-4254051
	Large Corporate Accounts	India_care_REL@dell.com toll-free: 1800-4252067
	Sales	
	Large Corporate Accounts	1600 33 8044
	Home and Small Business	1600 33 8046
Ireland (Cherrywood) International Access Code: 00 Country Code: 353	Online Support	support.euro.dell.com
		dell_direct_support@dell.com
	Technical Support	
	XPS computers only	1850 200 722
Business computers	1850 543 543	

City Code: 1	Home computers	1850 543 543
	At Home Support	1850 200 889
	Sales	
	Home	1850 333 200
	Small Business	1850 664 656
	Medium Business	1850 200 646
	Large Business	1850 200 646
	Sales E-mail	Dell_IRL_Outlet@dell.com
	Customer Service	
	Home and Small Business	01 204 4014
	Business (greater than 200 employees)	1850 200 982
	General	
	Fax/Sales Fax	01 204 0103
	Switchboard	01 204 4444
	U.K. Customer Service (dial within U.K. only)	0870 906 0010
	Corporate Customer Service (dial within U.K. only)	0870 907 4499
	U.K. Sales (dial within U.K. only)	0870 907 4000
Italy (Milan) International Access Code: 00 Country Code: 39 City Code: 02	Online Support	support.euro.dell.com
	Home and Small Business	
	Technical Support	02 577 826 90
	Customer Service	02 696 821 14
	Fax	02 696 821 13
	Switchboard	02 696 821 12
	Corporate	
	Technical Support	02 577 826 90
	Customer Service	02 577 825 55
	Fax	02 575 035 30
Switchboard	02 577 821	
Jamaica	Online Support	ja-techsupport@dell.com
	Technical Support, Customer Service, Sales (dial from within Jamaica only)	1-800-440-9205
Japan (Kawasaki) International Access Code: 001 Country Code: 81 City Code: 44	Online Support	support.jp.dell.com
	Technical Support – XPS computers only	toll-free: 0120-937-786
	Technical Support outside of Japan – XPS computers only	81-44-520-1235
	Technical Support – Dimension and Inspiron	toll-free: 0120-198-226
	Technical Support outside of Japan – Dimension and Inspiron	81-44-520-1435
	Technical Support – Dell Precision, OptiPlex, and Latitude	toll-free: 0120-198-433
	Technical Support outside of Japan – Dell Precision, OptiPlex, and Latitude	81-44-556-3894
	Technical Support – Dell PowerApp, Dell PowerEdge, Dell PowerConnect, and Dell PowerVault	toll-free: 0120-198-498
	Technical Support outside of Japan – PowerApp, PowerEdge, PowerConnect, and PowerVault	81-44-556-4162
	Technical Support – Projectors, PDAs, Printers, Routers	toll-free: 0120-981-690
Technical Support outside of Japan – Projectors, PDAs, Printers, Routers	81-44-556-3468	

	Faxbox Service	044-556-3490
	24-Hour Automated Order Status Service	044-556-3801
	Customer Service	044-556-4240
	Business Sales Division - up to 400 employees	044-556-1465
	Preferred Accounts Division Sales - over 400 employees	044-556-3433
	Public Sales - government agencies, educational institutions, and medical institutions	044-556-5963
	Global Segment Japan	044-556-3469
	Individual User	044-556-1657
	Individual User Online Sales	044-556-2203
	Individual User Real Site Sales	044-556-4649
Korea (Seoul) International Access Code: 001 Country Code: 82 City Code: 2	Online Support	support.ap.dell.com
	Technical Support for XPS computers only	toll-free: 080-999-0283
	Technical Support, Customer Service	toll-free: 080-200-3800
	Technical Support – Dimension, PDA, Electronics, and Accessories	toll-free: 080-200-3801
	Sales	toll-free: 080-200-3600
	Fax	2194-6202
	Switchboard	2194-6000
Latin America	Customer Technical Support (Austin, Texas, U.S.A.)	512 728-4093
	Customer Service (Austin, Texas, U.S.A.)	512 728-3619
	Fax (Technical Support and Customer Service) (Austin, Texas, U.S.A.)	512 728-3883
	Sales (Austin, Texas, U.S.A.)	512 728-4397
	SalesFax (Austin, Texas, U.S.A.)	512 728-4600 or 512 728-3772
Luxembourg International Access Code: 00 Country Code: 352	Online Support	support.euro.dell.com
	Support	342 08 08 075
	Home/Small Business Sales	+32 (0)2 713 15 96
	Corporate Sales	26 25 77 81
	Customer Service	+32 (0)2 481 91 19
	Fax	26 25 77 82
Malaysia (Penang) International Access Code: 00 Country Code: 60 City Code: 4	Online Support	support.ap.dell.com
	Technical Support - XPS computers only	toll-free: 1 800 885 784
	Technical Support - Dell Precision, OptiPlex, and Latitude	toll-free: 1 800 880 193
	Technical Support - Dimension, Inspiron, and Electronics and Accessories	toll-free: 1 800 881 306
	Technical Support - PowerApp, PowerEdge, PowerConnect, and PowerVault	toll-free: 1800 881 386
	Customer Service	toll-free: 1800 881 306(option6)
	Transaction Sales	toll-free: 1 800 888 202
	Corporate Sales	toll-free: 1 800 888 213
Mexico International Access Code: 00 Country Code: 52	Online Support	www.dell.com/mx
		la-techsupport@dell.com
	Technical Support	001-866-563-4425
	Sales	50-81-8800 or 01-800-888-3355
	Customer Service	001-877-384-8979 or 001-877-269-3383

	Main	50-81-8800 or 001-800-888-3355 or 001-866-851-1754
Montserrat	Online Support	la-techsupport@dell.com
	Technical Support, Customer Service, Sales	toll-free: 1-866-278-6822
Netherlands Antilles	Online Support	la-techsupport@dell.com
	Technical Support, Customer Service, Sales	001-800-882-1519
Netherlands (Amsterdam) International Access Code: 00 Country Code: 31 City Code: 20	Online Support	support.euro.dell.com
	Technical Support for XPS computers only	020 674 45 94
	Technical Support	020 674 45 00
	Technical Support Fax	020 674 47 66
	Home/Small Business Customer Service	020 674 42 00
	Relational Customer Service	020 674 4325
	Home/Small Business Sales	020 674 55 00
	Relational Sales	020 674 50 00
	Home/Small Business Sales Fax	020 674 47 75
	Relational Sales Fax	020 674 47 50
	Switchboard	020 674 50 00
	Switchboard Fax	020 674 47 50
New Zealand International Access Code: 00 Country Code: 64	Online Support	support.ap.dell.com
		support.ap.dell.com/contactus
	Technical Support for XPS computers only	toll-free: 0800 335 540
	Technical Support, Customer Service, Sales	0800 441 567
Nicaragua	Online Support	www.dell.com/ni
		la-techsupport@dell.com
	Technical Support, Customer Service, Salesz	001-800-220-1377
Norway (Lysaker) International Access Code: 00 Country Code: 47	Online Support	support.euro.dell.com
	Technical Support for XPS computers only	815 35 043
	Technical Support	671 16882
	Relational Customer Service	671 17575
	Home/Small Business Customer Service	23162298
	Switchboard	671 16800
Fax Switchboard	671 16865	
Panama	Online Support	www.dell.com/pa
		la-techsupport@dell.com
	Technical Support, Customer Service, Sales	011-800-507-1264
Peru	Online Support	www.dell.com/pe
		la-techsupport@dell.com
	Technical Support, Customer Service, Sales	0800-50-669
Poland (Warsaw) International Access Code: 011 Country Code: 48 City Code: 22	Online Support	support.euro.dell.com
		pl_support_tech@dell.com
	Customer Service Phone	57 95 700
	Customer Service	57 95 999
	Sales	57 95 999
	Customer Service Fax	57 95 806
	Reception Desk Fax	57 95 998
Switchboard	57 95 999	
Portugal International Access Code: 00	Online Support	support.euro.dell.com
	Technical Support	707200149
	Customer Service	800 300 413

Country Code: 351	Sales	800 300 410 or 800 300 411 or 800 300 412 or 21 422 07 10
	Fax	21 424 01 12
Puerto Rico	Online Support	www.dell.com/pr
		la-techsupport@dell.com
	Technical Support	toll-free: 1-866-390-4695 or 1-866-851-1760
	Customer Service and Sales	1-877-537-3355
St. Kitts and Nevis	Online Support	www.dell.com/kn
		la-techsupport@dell.com
	Technical Support, Customer Service, Sales	toll-free: 1-866-540-3355
St. Lucia	Online Support	www.dell.com/lc
		la-techsupport@dell.com
	Technical Support, Customer Service, Sales	toll-free: 1-866-464-4352
St. Vincent and the Grenadines	Online Support	www.dell.com/vc
		la-techsupport@dell.com
	Technical Support, Customer Service, Sales	toll-free: 1-866-464-4353
Singapore (Singapore) International Access Code: 005 Country Code: 65	NOTE: The phone numbers in this section should be called from within Singapore or Malaysia only.	
	Online Support	support.ap.dell.com
	Technical Support – XPS computers only	toll-free: 1800 394 7464
	Technical Support – Dimension, Inspiron, and Electronics and Accessories	toll-free: 1800 394 7430
	Technical Support – OptiPlex, Latitude, and Dell Precision	toll-free: 1800 394 7488
	Technical Support – PowerApp, PowerEdge, PowerConnect, and PowerVault	toll-free: 1800 394 7478
	Customer Service	toll-free: 1800 394 7430(option6)
	Transaction Sales	toll-free: 1 800 394 7412
	Corporate Sales	toll-free: 1 800 394 7419
Slovakia (Prague) International Access Code: 00 Country Code: 421	Online Support	support.euro.dell.com
		czech_dell@dell.com
	Technical Support	02 5441 5727
	Customer Service	420 22537 2707
	Fax	02 5441 8328
	Tech Fax	02 5441 8328
	Switchboard (Sales)	02 5441 7585
South Africa (Johannesburg) International Access Code: 09/091 Country Code: 27 City Code: 11	Online Support	support.euro.dell.com
		dell_za_support@dell.com
	Gold Queue	011 709 7713
	Technical Support	011 709 7710
	Customer Service	011 709 7707
	Sales	011 709 7700
	Fax	011 706 0495
Switchboard	011 709 7700	
Southeast Asian and Pacific Countries	Technical Support, Customer Service, and Sales (Penang, Malaysia)	604 633 4810
Spain (Madrid) International Access Code: 00 Country Code: 34 City Code: 91	Online Support	support.euro.dell.com
	Home and Small Business	
	Technical Support	902 100 130
	Customer Service	902 118 540
	Sales	902 118 541
	Switchboard	902 118 541

	Fax	902 118 539
	Corporate	
	Technical Support	902 100 130
	Customer Service	902 115 236
	Switchboard	91 722 92 00
	Fax	91 722 95 83
Sweden (Upplands Vasby) International Access Code: 00 Country Code: 46 City Code: 8	Online Support	support.euro.dell.com
	Technical Support for XPS computers only	77 134 03 40
	Technical Support	08 590 05 199
	Relational Customer Service	08 590 05 642
	Home/Small Business Customer Service	08 587 70 527
	Employee Purchase Program (EPP) Support	020 140 14 44
	Technical Support Fax	08 590 05 594
	Sales	08 587 705 81
Switzerland (Geneva) International Access Code: 00 Country Code: 41 City Code: 22	Online Support	support.euro.dell.com
		Tech_support_central_Europe@dell.com
	Technical Support for XPS computers only	0848 33 88 57
	Technical Support – Home and Small Business	0844 811 411
	Technical Support – Corporate	0844 822 844
	Customer Service – Home and Small Business	0848 802 202
	Customer Service – Corporate	0848 821 721
	Main	0848 335 599
	Fax	022 799 01 90
	Sales	022 799 01 01
Taiwan International Access Code: 002 Country Code: 886	Online Support	support.ap.dell.com
		support.dell.com.cn/email
	Technical Support – XPS computers only	toll-free: 0080 186 3085
	Technical Support – OptiPlex, Latitude, Inspiron, Dimension, and Electronics and Accessories	toll-free: 0080 186 1011
	Technical Support – servers and storage	toll-free: 0080 160 1256
	Customer Service	toll-free: 0080 160 1250 (option 5)
	Transaction Sales	toll-free: 0080 165 1228
	Corporate Sales	toll-free: 0080 165 1227
Thailand International Access Code: 001 Country Code: 66	Online Support	support.ap.dell.com
	Technical Support (OptiPlex, Latitude, and Dell Precision)	toll-free: 1800 0060 07
	Technical Support (PowerApp, PowerEdge, PowerConnect, and PowerVault)	toll-free: 1800 0600 09
	Customer Service	toll-free: 1800 006 007 (option7)
	Corporate Sales	toll-free: 1800 006 009
	Transaction Sales	toll-free: 1800 006 006
Trinidad/Tobago	Online Support	www.dell.com/tt
		la-techsupport@dell.com
	Technical Support, Customer Service, Sales	1-888-799-5908
Turks and Caicos Islands	Online Support	www.dell.com/tc
		la-techsupport@dell.com
	Technical Support, Customer Service, Sales	toll-free: 1-877-441-4735
U.K. (Bracknell)	Online Support	support.euro.dell.com

International Access Code: 00 Country Code: 44 City Code: 1344		dell_direct_support@dell.com
	Customer Service Online	support.euro.dell.com/uk/en/ECare/Form/Home.asp
	Sales	
	Home and Small Business Sales	0870 907 4000
	Corporate/Public Sector Sales	01344 860 456
	Customer Service	
	Home and Small Business	0870 906 0010
	Corporate	01344 373 185
	Preferred Accounts (500-5000 employees)	0870 906 0010
	Global Accounts	01344 373 186
	Central Government	01344 373 193
	Local Government & Education	01344 373 199
	Health	01344 373 194
	Technical Support	
	XPS Computers Only	0870 366 4180
	Corporate/Preferred Accounts/PAD (1000+ employees)	0870 908 0500
	Other Dell Products	0870 353 0800
	General	
	Home and Small Business Fax	0870 907 4006
	Uruguay	Online Support
		la-techsupport@dell.com
Technical Support, Customer Service, Sales		toll-free: 000-413-598-2521
U.S.A. (Austin, Texas) International Access Code: 011 Country Code: 1	Dell Services for the Deaf, Hard-of-Hearing, or Speech-Impaired	toll-free: 1-877-Dell™TY (1-877-335-5889)
	Fax	toll-free: 1-800-727-8320
	Technical Support	support.dell.com
	XPS	toll-free: 1-800-232-8544
	Home and Home Office	toll-free: 1-800-624-9896
	Portable and Desktop AutoTech	toll-free: 1-800-247-9362
	Small Business	toll-free: 1-800-456-3355
	Medium and Large Business	toll-free: 1-877-671-3355
	State and Local Government	toll-free: 1-800-981-3355
	Federal Government	toll-free: 1-800-727-1100
	Healthcare	toll-free: 1-800-274-1550
	K-12 Education	toll-free: 1-888-977-3355
	Higher Education	toll-free: 1-800-274-7799
	Printers, Projectors, PDAs, and MP3 Players	toll-free: 1-877-459-7298
	Customer Service	toll-free: 1-800-624-9897
	Automated Order Status	toll-free: 1-800-433-9014
	Small Business	toll-free: 1-800-456-3355
	Medium and Large Business	toll-free: 1-877-671-3355
	State and Local Government	toll-free: 1-800-981-3355
	Federal Government	toll-free: 1-800-727-1100
	Healthcare	toll-free: 1-800-274-1550
	K-12 Education	toll-free: 1-888-977-3355
	Higher Education	toll-free: 1-800-274-7799
	Employee Purchase Program (EPP)	toll-free: 1-800-695-8133

	Financial Services	www.dellfinancialservices.com
	Leases and Loans	toll-free: 1-877-577-3355
	Dell Preferred Accounts (DPA)	toll-free: 1-800-283-2210
	Sales	1-800-289-3355 or 1-800-879-3355
	Dell Outlet Store	toll-free: 1-888-798-7561
	Software and Peripherals Sales	toll-free: 1-800-671-3355
U.S. Virgin Islands	Online Support	www.dell.com/vi
		la-techsupport@dell.com
	Technical Support, Customer Service, Sales	toll-free: 1-877-702-4360
Venezuela	Online Support	www.dell.com/ve
		la-techsupport@dell.com
	Technical Support, Customer Service, Sales	0800-100-4752

[Back to Contents Page](#)

Setting Up Your Monitor

Dell™ E198FP Flat Panel Monitor

- [Connecting Your Monitor](#)
- [Using the Front Panel Buttons](#)
- [Using the OSD](#)
- [Using the Dell Soundbar \(Optional\)](#)

Connecting Your Monitor

⚠ CAUTION: Before you begin any of the procedures in this section, follow the [Safety Instructions](#).

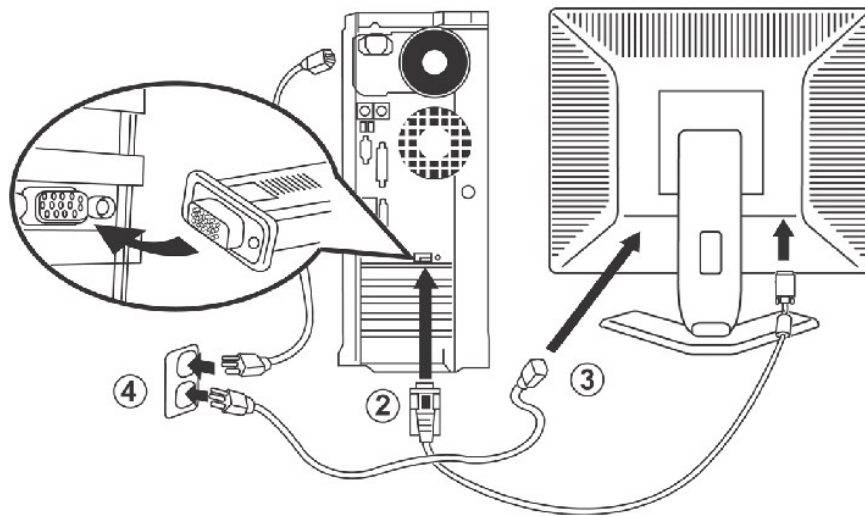





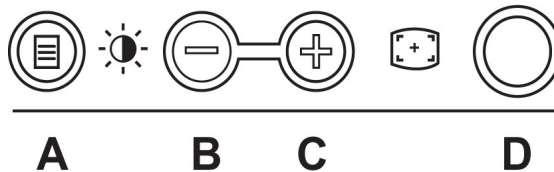

1. Turn off your computer and unplug its power cable.
2. Connect the blue (analog D-sub) display connector cable to the corresponding video port on the back of your computer. (The graphic is for illustration only. System appearance may vary).
3. Connect the power cable for your display to the power port on the back of the display.
4. Plug the power cables of your computer and your display into a nearby outlet. Your monitor is equipped with an automatic power supply for a voltage range from 100 to 240 Volt at a frequency of 50/60 Hz. Be sure that your local power is within the supported range. If you are unsure, ask your electricity supplier.
5. Turn on your display and computer.

If your monitor displays an image, installation is complete. If it does not display an image, see [Troubleshooting](#).

Using the Front Panel Buttons





Use the control buttons on the front of the monitor to adjust the characteristics of the image being displayed. As you use these buttons to adjust the controls, an OSD shows their numeric values as they change.



A	 MENU	<p>The 'MENU' button is used to open the on-screen display (OSD), select function icons, exit from menus and sub-menus, and to exit the OSD. See Accessing the Menu System.</p>
B	 Brightness/Contrast Hot Key	<p>Use this button for direct access to the 'Brightness' and 'Contrast' control menu.</p>
B C	 - and + buttons	<p>Use these buttons to adjust (decrease/increase ranges) items in the OSD.</p> <p>NOTE: You can activate automatic scroll feature by pressing and holding either + or - button.</p>
C	 Auto Adjust	<p>Use this button to activate automatic setup and adjustment. The following dialog will appear on screen as the monitor self-adjusts to the current input:</p> <div style="text-align: center; border: 1px solid black; padding: 5px; width: fit-content; margin: 10px auto;"> Auto Adjust In Progress </div> <p>Auto Adjustment  button allows the monitor to self-adjust to the incoming video signal. After using 'Auto Adjustment', you can further tune your monitor by using the 'Pixel Clock' and 'Phase' controls in the OSD.</p> <p>NOTE: Auto Adjust will not occur if you press the button while there are no active video input signals, or attached cables.</p>
D	 Power Button & Indicator	<p>The green LED indicates the monitor is on and fully functional. An amber LED indicates DPMS power save mode.</p> <p>The Power button turns the monitor on and off.</p>

On Screen Menu/Display (OSD)

Direct-Access Functions

Function	Adjustment Method
Auto adjustment	<p>Use this button to activate automatic setup and adjustment. The following dialog will appear on screen as the monitor self-adjusts to the current input:</p> <div style="text-align: center; border: 1px solid black; padding: 5px; width: fit-content; margin: 10px auto;"> Auto Adjust In Progress </div> <p>Auto Adjustment  button allows the monitor to self-adjust to the incoming video signal. After using Auto Adjustment, you can further tune your monitor by using the Pixel Clock and Phase controls in the OSD.</p> <p>NOTE: Auto Adjust will not occur if you press the button while there are no active video input signals, or attached cables.</p>
Brightness / Contrast <div style="border: 1px solid black; padding: 5px; margin-top: 10px;"> <p style="text-align: center;">Brightness/Contrast</p> <p>Exit </p> <p>Brightness  - + 75 </p> <p>Contrast  - + 75 </p> </div>	<p>With the menu off, push  button to display the 'Brightness' and 'Contrast' adjustment menu.</p> <p>The Brightness function adjusts the luminance of the flat panel.</p> <p>Adjust 'Brightness' first, then adjust 'Contrast' only if further adjustment is necessary.</p> <p>"+" increase 'brightness' "- "decrease 'brightness'</p> <p>The Contrast function adjusts the degree of difference between darkness and lightness on the display screen.</p> <p>"+" increase the 'contrast' "- "decrease the 'contrast'</p>

Using the OSD

Accessing the Menu System

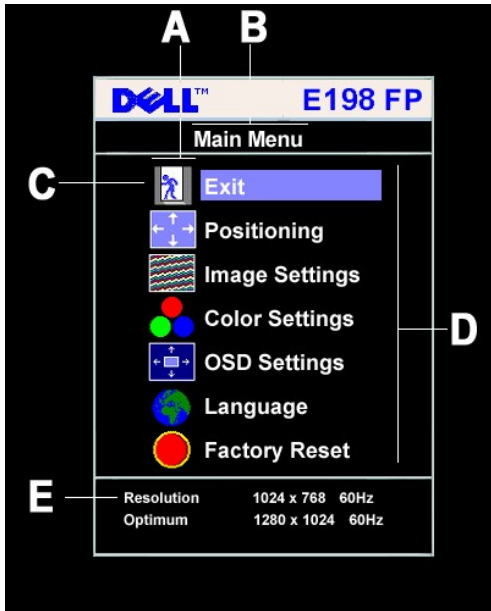

1. With the menu off, push the **MENU** button to open the OSD system and display the main features menu.





- A Function icons B Main Menu C Menu icon
D Sub-Menu name E Resolution







2. Push the - and + buttons to move between the function icons. As you move from one icon to another, the function name is highlighted to reflect the function or group of functions (sub-menus) represented by that icon. See the table below for a complete list of all the functions available for the monitor.
3. Push the **MENU** button once to activate the highlighted function; Push -/+ to select the desired parameter, push menu to enter the sidebar then use the - and + buttons, according to the indicators on the menu, to make your changes.
4. Push the **MENU** button once to return to the main menu to select another function or push the **MENU** button two or three times to exit from the OSD.

Icon	Menu Name and Sub-menus	Description
	EXIT	This is used to exit out of the 'Main menu'.
	Positioning Horizontal Vertical	<p>Positioning moves the viewing area around on the monitor screen.</p> <p>When making changes to either the Horizontal or Vertical settings, no changes will occur to the size of the viewing area; the image gets shifted based on what you select.</p> <p>Minimum is '0' (-). Maximum is '100' (+).</p> <div style="text-align: center;"> </div>
	Image Settings	

	<p>Auto Adjust</p>	<p>Even though your computer system can recognize your new flat panel monitor on startup, the 'Auto Adjustment' function will optimize the display settings for use with your particular setup.</p> <p>NOTE: In most cases, 'Auto Adjust' produces the best image for your configuration; you can directly access this function via Auto Adjustment  hotkey.</p>
	<p>Pixel Clock</p>	<p>The 'Phase' and 'Pixel Clock' adjustments allow you to more closely adjust your monitor to your preference. Select Image Settings in the main OSD to access these settings.</p> <p>Use the - and + buttons to adjust interference. Minimum: 0 ~ Maximum: 100</p>
	<p>Phase</p>	<p>If satisfactory results are not obtained using the Phase adjustment, use the Pixel Clock adjustment and then use Phase again.</p> <div data-bbox="646 478 1144 865" data-label="Image"> </div> <p>NOTE: This function may change the width of the display image. Use the 'Horizontal' function of the 'Position' menu to center the display image on the screen.</p>

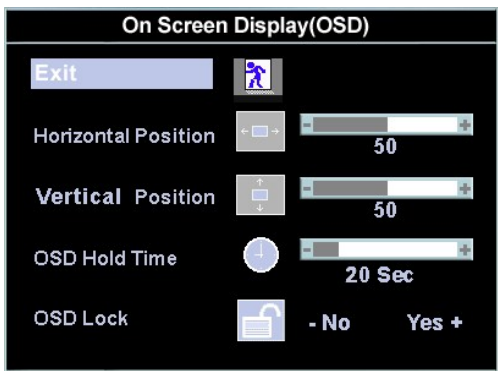
	<p>Color Settings</p>	<p>'Color Settings' adjusts the color temperature and saturation.</p> <div data-bbox="652 982 1140 1360" data-label="Image"> </div> <p>Normal Preset 'Normal Preset' is selected to obtain the default (factory) color settings.</p> <p>Blue Preset 'Blue Preset' is selected to obtain a bluish tint. This color setting is typically used for text based applications (Spreadsheets, Programming, Text Editors etc.).</p> <p>Red Preset 'Red Preset' is selected to obtain a redder tint. This color setting is typically used for color intensive applications (Photograph Image Editing, Multimedia, Movies etc.).</p> <p>User Preset 'User Preset': Use the plus and minus buttons to increase or decrease each of the three colors (R, G, B) independently, in single digit increments, from '0' to '100'.</p> <p>NOTE: 'Color temperature' is a measure of the 'warmth' of the image colors (red/green/blue). The two available presets ('Blue' and 'Red') favor blue and red accordingly. Select each one to see how each range suits your eye; or utilize the 'User Preset' option to customize the color settings to your exact choice.</p>
-----------------------------------------------------------------------------------	------------------------------	------------------------------------------------------------------------------------------------------------------------------------------------------------------------------------------------------------------------------------------------------------------------------------------------------------------------------------------------------------------------------------------------------------------------------------------------------------------------------------------------------------------------------------------------------------------------------------------------------------------------------------------------------------------------------------------------------------------------------------------------------------------------------------------------------------------------------------------------------------------------------------------------------------------------------------------------------------------------------------------------------------------------------------------------------------------------------------------------------------------------------------------------------------------------------------------

	<p>OSD Settings</p>	<p>Each time the OSD opens, it displays in the same location on the screen. 'OSD Settings' (horizontal/vertical) provides control over this location.</p> <p>Horizontal Position - and + buttons move OSD to the left and right.</p>
-------------------------------------------------------------------------------------	----------------------------	---------------------------------------------------------------------------------------------------------------------------------------------------------------------------------------------------------------------------------------------

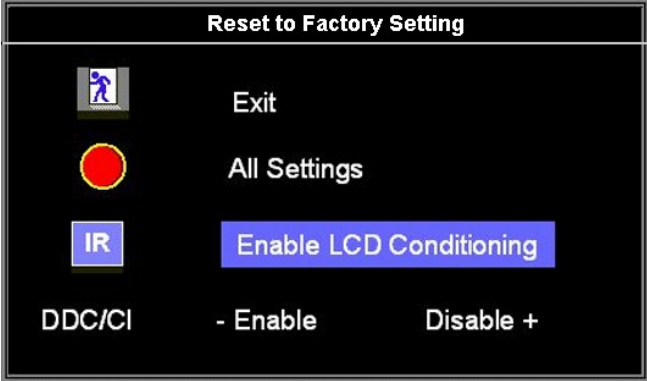
  	<p>Vertical Position - and + buttons move OSD down and up.</p> <p>OSD Hold Time The OSD stays active for as long as it is in use. 'OSD Hold Time': Sets the length of time the OSD will remain active after the last time you pressed a button. Use the - and + buttons to adjust the slider in 5 second increments, from 5 to 60 seconds.</p> <p>NOTE: Default 'OSD hold time' is 20 seconds.</p> <p>OSD Lock 'OSD Lock': Controls user access to adjustments. When 'Yes' (+) is selected, no user adjustments are allowed. All buttons are locked except the menu button.</p> <p>All buttons can be locked or unlocked when the 'Menu' button is pushed and held for over 15 seconds.</p>	 <p>NOTE: When the OSD is locked, pressing the Menu button will take the user directly to the 'OSD settings' menu, with 'OSD Lock' preselected on entry. Select 'No' (-) to unlock and allow user access to all applicable settings.</p>
	<p>Language</p>	<p>Language sets the OSD to display in one of the five languages (English, Español, Français, Deutsch, Japanese).</p>  <p>NOTE: The language chosen affects only the language of the OSD. It has no effect on any software running on the computer.</p>
	<p>Factory Reset</p>	<p>Factory Reset returns the settings to the factory preset values for the selected group of functions.</p>  <p>Exit is used to exit out of Factory Reset menu.</p> <p>For All settings, all user adjustable settings are reset at one time except language settings.</p> <p>IR - This feature will help reduce minor cases of image retention.</p> <p>Enable LCD Conditioning: If an image appears to be stuck on the monitor, select LCD Conditioning to help eliminate any image</p>

retention. Using the LCD Conditioning feature may take several hours. Severe cases of image retention are known as burn-in, the LCD Conditioning feature does not remove burn-in.

NOTE: Use LCD Conditioning only when you experience a problem with image retention.

Below warning message appears once user select "Enable LCD Conditioning":

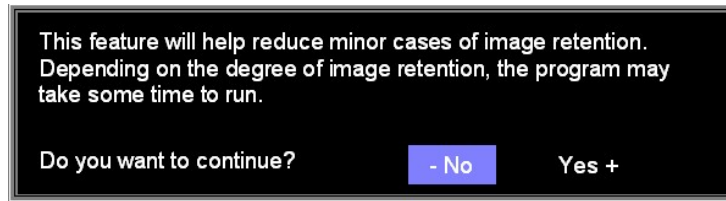

NOTE: Press any button on the monitor to terminate LCD Conditioning at any time.

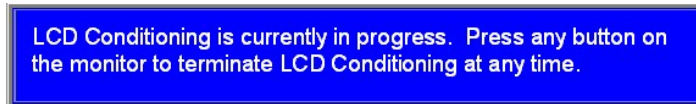

DDC/CI (Display Data Channel/Command Interface) allows you to adjust the monitor parameters (brightness, color, balance, etc.) via software applications on your PC.

Select **Disable** to disable this feature.
For best user experience and optimum performance of your monitor, keep this feature enabled.



NOTE: If user select 'disable' for DDC/CI, the warning message will appear on screen. Then user can select Yes or No according to need.

Automatic Save

With the OSD open, if you make an adjustment and then either proceed to another menu, or exit the OSD, the monitor automatically saves any adjustments you have made. If you make an adjustment and then wait for the OSD to disappear the adjustment will also be saved.

OSD Warning Messages

A warning message appears on the screen indicating that the monitor is out of sync.

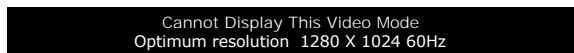

This means that the monitor cannot synchronize with the signal that it is receiving from the computer. Either the signal is too high or too low for the monitor to use. See [Specifications](#) for the Horizontal and Vertical frequency ranges addressable by this monitor. Recommended mode is 1280 X 1024 @ 60Hz.

NOTE: The floating 'Dell - self-test Feature Check' dialog will appear on-screen if the monitor cannot sense a video signal.

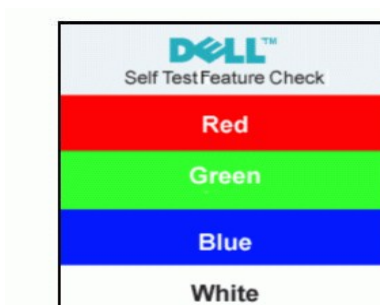

Occasionally, no warning message appears, but the screen is blank. This could also indicate that the monitor is not synchronizing with the computer.

See [Troubleshooting](#) for more information.

Using the Dell Soundbar (Optional)

The Dell Soundbar is a four-speaker, two-channel system adaptable to mount on Dell™ Flat Panel Displays. The Soundbar has a rotary volume and on/off control to adjust the overall system level, a blue LED for power indication, and two audio headset jacks.



1. Headphone connectors
2. Power indicator
3. Power/Volume control

Soundbar Attachment to the Monitor





1. Working from the rear of the monitor, attach Soundbar by aligning the two slots with the two tabs along the bottom rear of the monitor.
2. Slide the Soundbar to the left until it snaps into the place.
3. Connect the Soundbar with the power brick.
4. Plug the power cables of the power brick into a nearby outlet.
5. Insert the lime green mini stereo plug from the rear of the Soundbar into the computer's audio output jack.

 **NOTICE:** Do not use with any device other than Dell Soundbar.

 **NOTE:** Soundbar Power Connector - 12V DC output is for optional Dell Soundbar only.

[Back to Contents Page](#)

Solving Problems

Dell™ E198FP Flat Panel Monitor

- [Monitor Specific Troubleshooting](#)
- [Common Problems](#)
- [Product Specific Problems](#)

⚠ CAUTION: Before you begin any of the procedures in this section, follow the [Safety Instructions](#).

Monitor Specific Troubleshooting

Self-Test Feature Check (STFC)

Your monitor provides a self-test feature that allows you to check whether your monitor is functioning properly. If your monitor and computer are properly connected but the monitor screen remains dark, run the monitor self-test by performing the following steps:

1. Turn off both your computer and the monitor.
2. Unplug the video cable from the back of the computer. To ensure proper Self-Test operation, remove the Analog (blue connector) cables from the back of computer.
3. Turn on the monitor.

The floating 'Dell - Self-Test Feature Check' dialog box should appear on-screen (against a black background) if the monitor cannot sense a video signal and is working correctly. While in self-test mode, the power LED remains green. Also, depending upon the selected input, one of the dialogs shown below will continuously scroll through the screen.

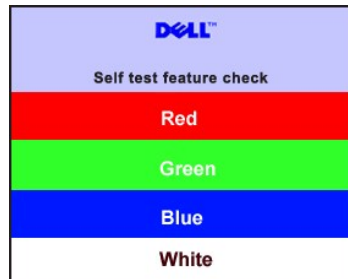

4. This box also appears during normal system operation if the video cable becomes disconnected or damaged.
5. Turn off your monitor and reconnect the video cable; then turn on both your computer and the monitor.

If your monitor screen remains blank after you use the previous procedure, check your video controller and computer system; your monitor is functioning properly.

OSD Warning Messages

For OSD-related issues, see [OSD Warning Messages](#)

Common Problems

The following table contains general information about common monitor problems you might encounter.

COMMON SYMPTOMS	WHAT YOU EXPERIENCE	POSSIBLE SOLUTIONS
No Video/ Power LED off	No picture, monitor is dead	<ul style="list-style-type: none">1 Check connection integrity at both ends of the video cable1 Electric outlet verification1 Ensure power button depressed fully
No Video/ Power LED on	No picture or no brightness	<ul style="list-style-type: none">1 Increase brightness & contrast controls1 Perform monitor self-test feature check1 Check for bent or broken pins
Poor Focus	Picture is fuzzy, blurry or ghosting	<ul style="list-style-type: none">1 Push Auto Adjust button1 Adjust Phase and Clock controls via OSD1 Eliminate video extension cables1 Perform monitor reset1 Lower video resolution or increase font size

Shaky/Jittery Video	Wavy picture or fine movement	<ul style="list-style-type: none"> 1 Push Auto Adjust button 1 Adjust Phase and Clock controls via OSD 1 Perform monitor reset 1 Check environmental factors 1 Relocate and test in another room
Missing Pixels	LCD screen has spots	<ul style="list-style-type: none"> 1 Cycle power on-off 1 These are pixels that are permanently off and is a natural defect that occurs in LCD technology
Stuck-on Pixels	LCD screen has bright spots	<ul style="list-style-type: none"> 1 Cycle power on-off 1 These are pixels that are permanently on and is a natural defect that occurs in LCD technology
Brightness Problems	Picture too dim or too bright	<ul style="list-style-type: none"> 1 Perform monitor reset on "All Settings" 1 Push Auto Adjust button 1 Adjust brightness & contrast controls
Geometric Distortion	Screen not centered correctly	<ul style="list-style-type: none"> 1 Perform monitor reset on "Position Settings Only" 1 Push auto-adjust button 1 Adjust the centering controls 1 Ensure monitor is in proper video mode
Horizontal/Vertical Lines	Screen has one or more lines	<ul style="list-style-type: none"> 1 Perform monitor reset on "All Settings" 1 Push Auto Adjust button 1 Adjust Phase and Clock controls via OSD 1 Perform monitor self-test feature check and determine if these lines are also in self-test mode 1 Check for bent or broken pins
Sync Problems	Screen is scrambled or appears torn	<ul style="list-style-type: none"> 1 Perform monitor reset on "All Settings" 1 Push Auto Adjust button 1 Adjust Phase and Clock controls via OSD 1 Perform monitor self-test feature check to determine if scrambled screen appears in self-test mode 1 Check for bent or broken pins 1 Boot up in the "safe mode"
LCD Scratched	Screen has scratches or smudges	<ul style="list-style-type: none"> 1 Turn monitor off and clean the screen 1 For cleaning instruction, see Cleaning for Your Monitor.
Safety Related Issues	Visible signs of smoke or sparks	<ul style="list-style-type: none"> 1 Do not perform any troubleshooting steps 1 Monitor needs to be replaced
Intermittent Problems	Monitor malfunctions on & off	<ul style="list-style-type: none"> 1 Ensure monitor is in proper video mode 1 Ensure video cable connection to computer and to the flat panel is secure 1 Perform monitor reset on "All Settings" 1 Perform monitor self-test feature check to determine if the intermittent problem occurs in self-test mode
Missing Color	Picture missing color	<ul style="list-style-type: none"> 1 Perform monitor self-test feature check 1 Check connection integrity at both end of the video cable 1 Check for bent or broken pins
Wrong Color	Picture color not good	<ul style="list-style-type: none"> 1 Change the color to "User Preset" 1 Adjust R/G/B value of "User Preset"
Image retention from a static image left on the monitor for a long period of time	Faint shadow from the static image displayed appears on the screen	<ul style="list-style-type: none"> 1 Use the Power Management feature to turn off the monitor at all times when not in use. Alternatively, use a dynamically changing screensaver 1 In OSD Menu, under Reset to Factory Settings, select Enable LCD Conditioning. Using this option may take several hours before the image is eliminated <p>NOTE: Image Burn-in is not covered by your warranty.</p>

Product Specific Problems

SPECIFIC SYMPTOMS	WHAT YOU EXPERIENCE	POSSIBLE SOLUTIONS
Screen image is too small	Image is centered on screen, but does not fill entire viewing area	<ul style="list-style-type: none"> 1 Perform monitor reset on "All Settings"
Cannot adjust the monitor with the buttons on the front panel	OSD does not appear on the screen	<ul style="list-style-type: none"> 1 Turn the monitor off and unplug the power cord and then plug back and power on

		<ul style="list-style-type: none"> 1 The OSD Lock is On. Press the menu button for 15 seconds to unlock the OSD menu.
The monitor will not go into power saving mode.	No picture, the LED light is green. When press "+", "-" or "Menu" key, the message " No input signal " will appear.	<ul style="list-style-type: none"> 1 Move mouse or hit any key on the keyboard on the computer or activate video player, then access the OSD to set both Audio/Video to " off " state.
No Input Signal when user controls pressed	No picture, the LED light is green. When press "+", "-" or "Menu" key, the message " No input signal " will appear.	<ul style="list-style-type: none"> 1 Check the signal source Make sure the Computer is not in power saving by moving mouse or pressing any key on the keyboard. 1 Check whether the signal cable is plugged in and seated properly. Re-plug the signal cable if necessary. 1 Re-boot the computer or video player.

[Back to Contents Page](#)

Using Your Monitor Stand

Dell™ E198FP Flat Panel Monitor

- [Attaching the Stand](#)
 - [Organizing Your Cables](#)
 - [Using the Tilt](#)
 - [Removing the Stand](#)
-

Attaching the Stand

 **NOTE:** Stand is detached when the monitor is shipped from the factory.



1. Place the stand on a flat surface.
 2. Fit the groove on the back of the monitor onto the two teeth of upper stand.
 3. Lower the monitor so that the monitor mounting area snaps on/locks to stand.
-

Organizing Your Cables



After attaching all necessary cables to your monitor and computer, (See [Connecting Your Monitor](#) for cable attachment,) use the cable holder to neatly organize all cables as shown above.

Using the Tilt

With the built-in pedestal, you can tilt the monitor to best suit your viewing needs.

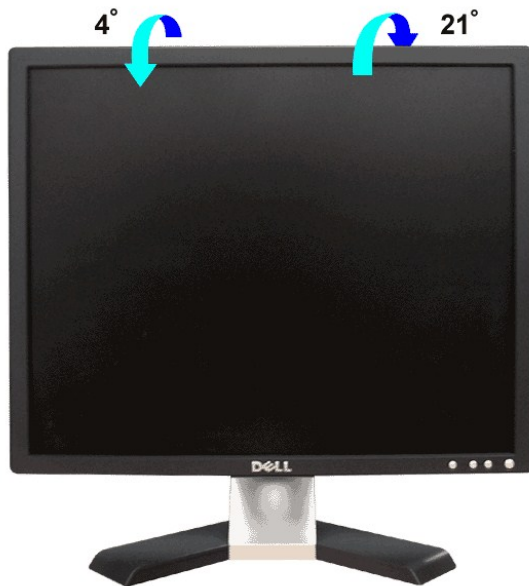

Removing the Stand

After placing the monitor panel on a soft cloth or cushion, press and hold the LCD removal button, and then remove the stand.

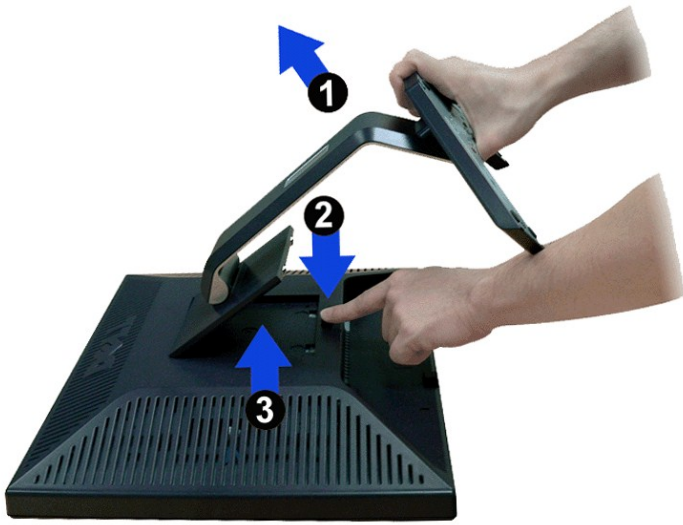

 **NOTE:** To prevent scratches on the LCD screen while removing the stand, ensure that the monitor is placed on a clean surface.

[Back to Contents Page](#)